

REV.	DESCRIPTION	APPD	DATE

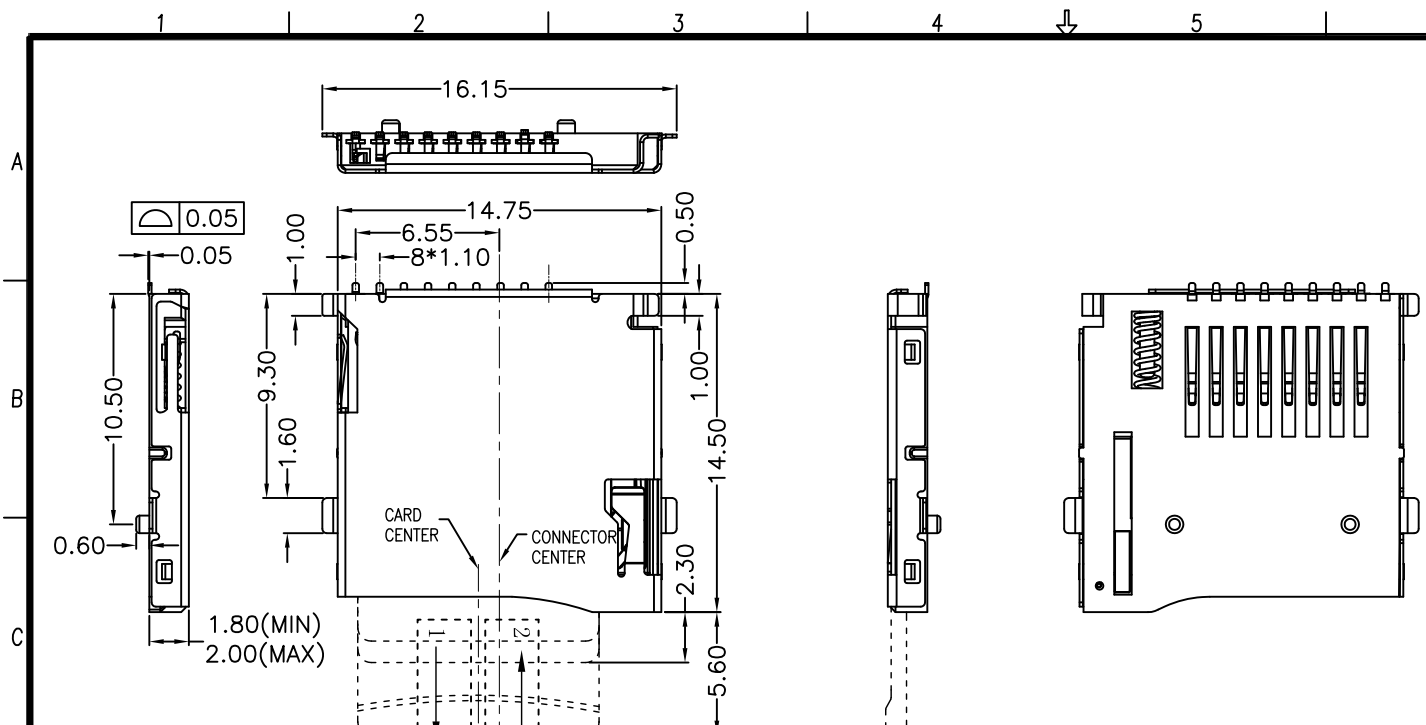

NOTES:
 1.MATERIAL:
 HOUSING: HIGH TEMPERATURE THERMOPLASTIC UL94V_0,COLOR:BLACK.
 CONTACT: COPPER ALLOYS.
 COVER: COPPER ALLOYS OR STEEL.
 2.PLATING:
 UNDERPLATE: NICKEL.
 CONTACT AREA: GOLD OVER NICKEL.
 SOLDER AREA: TIN OVER NICKEL.
 3.MULTIMEDIA CARD COMPATIBLE

订购须知
 TFWF1-BBXX-1X0X
 S1 接触区域镀金 1 卷带包装
 F1 全部区域镀金 3 PS盘包装

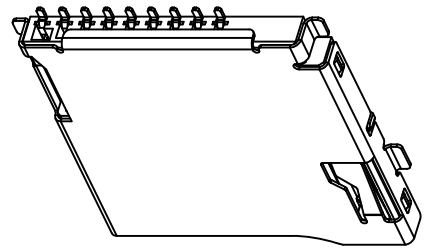
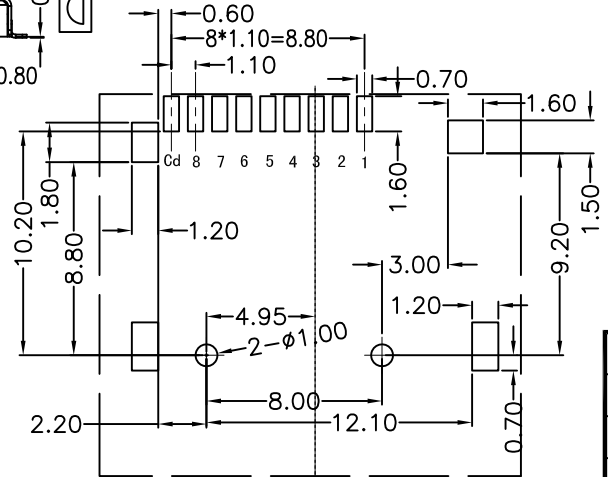
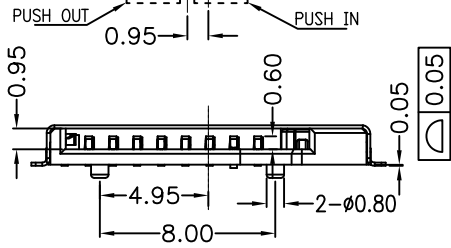
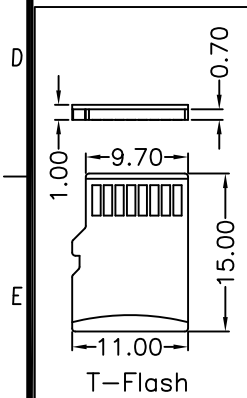

RECOMMENDED P.C.B HOLE LAYOUT
 COMPONENT SIDE VIEW(TOLERANCE: +/-0.05)

PIN NO.	NAME	YTYPE	DESCRIPTION
1	DAT2	I/O/PP	DATE LINE(BIT2)
2	CD/DAT3	I/O/PP	CARD DETECT DATE LIN(BIT3)
3	CMD	PP	COMMAND RESPONSE
4	VDD	S	SUPPLY VOLTAGE
5	CLX	I	CLOCK
6	VSS	S	SUPPLY VOLTAGE GROUND
7	DAT0	I/O/PP	DATE LINE(BIT0)
8	DAT1	I/O/PP	DATE LINE(DIT1)

PART NO: TFWF1-EBXX-1X0X		MATERIAL:		深圳市山谷道电子有限公司 电话: 0755-27759859 传真: 0755-27759850	
LOT NO: 11XX00011X		FINSH:			
UNIT: MM	SIZE: A4	COLOR:		TITLE: T-FLASH 外焊 PUSH (手机版)	
TOLERANCES: X.X=±0.35 X.XX=±0.25 X.XXX=±0.15		GENERAL ANGLE: X.X=±3.0° X.XX=±2.0°		DR: PENTIUM 0826'09	DWG NO: FP-090012
APP:		SCALE: 1:1		SHEET: 1 OF 3	REV: B/1

REV.	DESCRIPTION	APPD	DATE

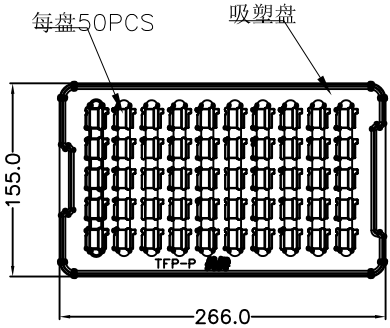

吸塑盘规格: 266*155*9
料厚0.35

NO. 1

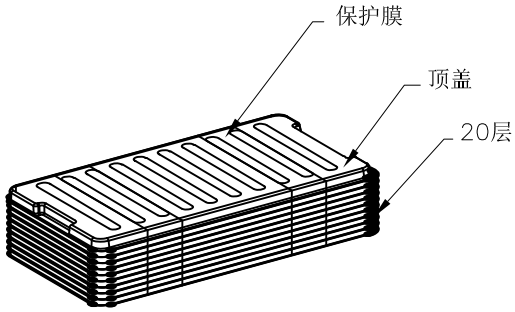

NO. 2

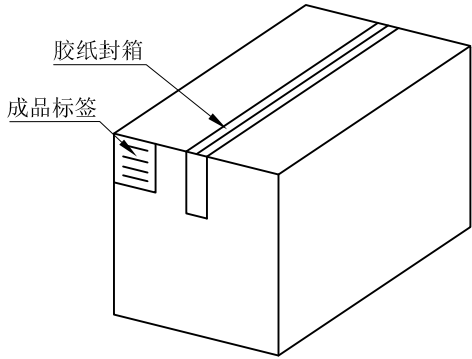

纸箱规格: 290*170*185

NO. 4

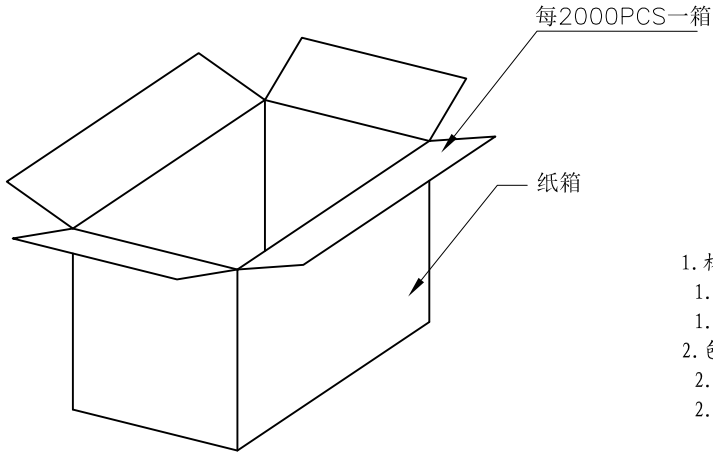

NO. 3

1. 材质要求:
- 1.1 纸箱的材质为B=B; 外形尺寸为29*17*18.5CM;
 - 1.2 PS盘的材质为PS, PS盘的外形尺寸266*155*9MM;
2. 包装要求:
- 2.1 每一盘装50PCS;
 - 2.2 每20盘累叠在一起, 共计1Kset, 上面需放一个空盘, 后用PE膜缠绕;
 - 2.3 把累叠好的PS盘两叠放入纸箱中共计2Kset;
 - 2.4 把包装好的成品打包封箱, 并在纸箱外贴上标签;

PART NO: TFWF1-EBXX-1X0X		MATERIAL:		深圳市山谷道电子有限公司	
LOT NO:		FINSH:		电话: 0755-27759859	
UNIT: MM	SIZE: A4	COLOR:		传真: 0755-27759850	
TOLERANCES: X.X=±0.35 X.XX=±0.25 X.XXX=±0.15		GENERAL ANGLE: X.X=±3.0° X.XX=±2.0°		TITLE: T-FLASH 外焊 PUSH (手机版)	
DR: PENTIUM 0826'09		CHK:		DWG NO: FP-090012	
APP:		SCALE: 1:1		REV: B/1	
		SHEET: 2 OF 3			

REV.	DESCRIPTION	APPD	DATE

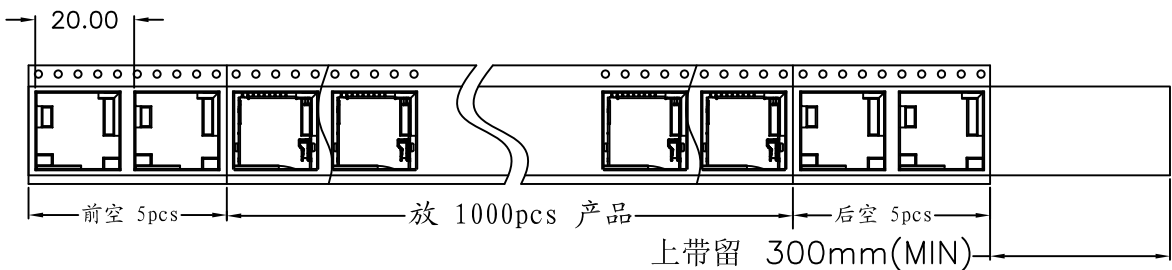
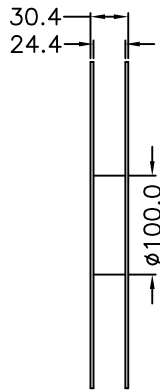
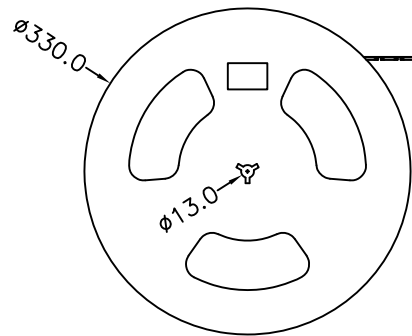
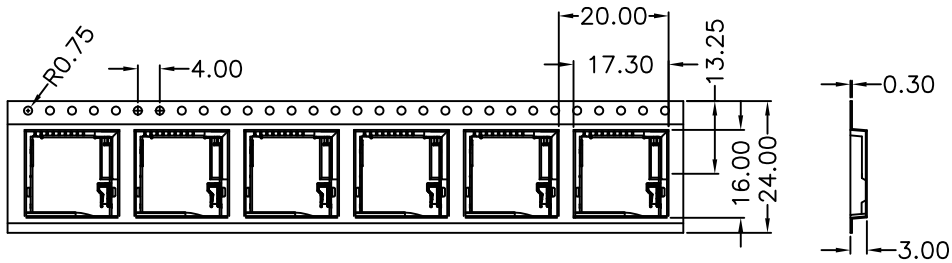

NO. 1

NO. 2

12盘

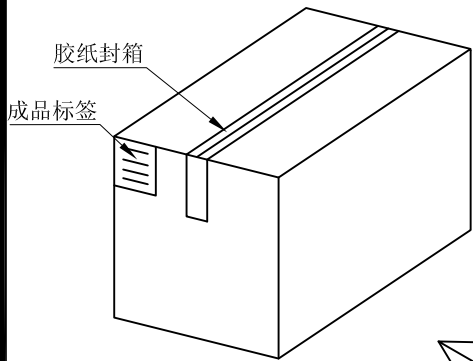

纸箱规格: 330*330*385

NO. 4

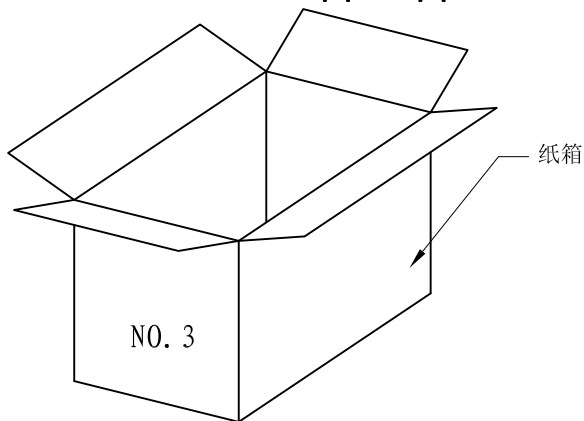

NO. 3

1. 材质要求:
- 1.1 纸箱的材质为B=B; 外形尺寸为33*33*38.5;
 - 1.2 卷盘的材质为PVC, 卷盘的外形尺寸为 $\phi 330*30.4$;
 - 1.3 卷带的材质为PVC, 卷带的外形尺寸为20200*24.00*3.0mm;
2. 包装方式:
- 2.1 将卷带放入包装机后, 前空5PCS, 后放产品1000PCS, 再后空5PCS; 上带留300MM长度。
 - 2.2 将包装好的产品从包装机上取下并包装好;
 - 2.3 把累叠好的12盘叠放入纸箱中共计12Kset;
 - 2.4 把包装好的成品打包封箱, 并在纸箱外贴上标签

PART NO: TFWF1-EBXX-1X0X		MATERIAL:		深圳市山谷道电子有限公司 电话: 0755-27759859 传真: 0755-27759850	
LOT NO:		FINSH:			
UNIT: MM	SIZE: A4	COLOR:		TITLE: T-FLASH 外焊 PUSH (手机版)	
TOLERANCES: X.X=±0.35 X.XX=±0.25 X.XXX=±0.15		GENERAL ANGLE: X.X=±3.0° X.XX=±2.0°		DR: PENTIUM 0826'09	
APP:		CHK:		DWG NO: FP-090012	
SCALE: 1:1		SHEET: 3 OF 3		REV: B/1	