

Box Header
Straight Dip Type/ Right Angle Dip Type
S.M.T Type

Pitch: 1.27 x 1.27mm

Series
303

sgdconn

Http://www.sgdconn.com

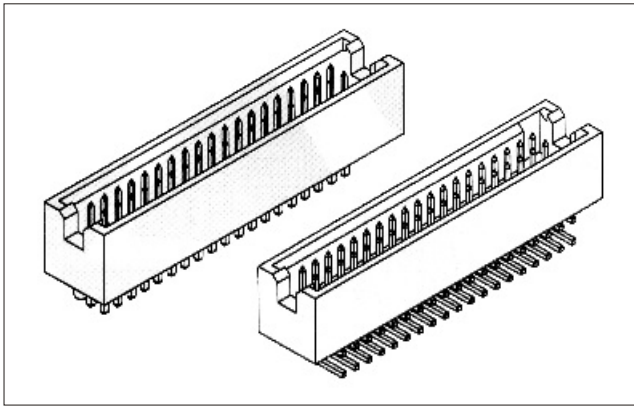

SPECIFICATIONS:

Current Rating: 1.0 AMP
Contact Resistance: 30mΩ Max
Insulation Resistance: 1000MΩ Min
Withstand Voltage: 300VAC/minute
Operation Temperature: -40°C to +105°C

MATERIALS:

Contact Material: Copper Alloy
Contact Plating: Gold or Tin over 50μ Ni
Insulator: Glass Filled Polyester (UL94V-0)
Standard: Nylon-6T

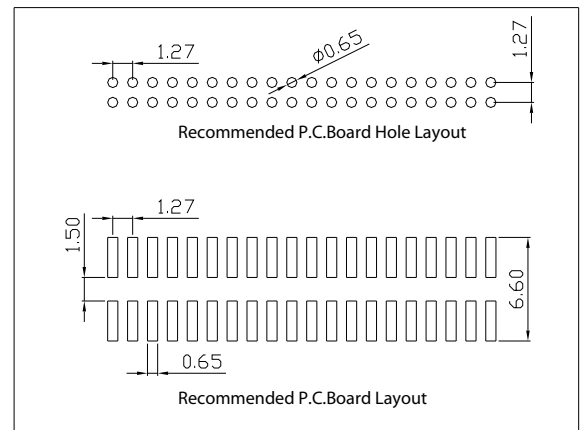
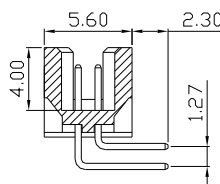
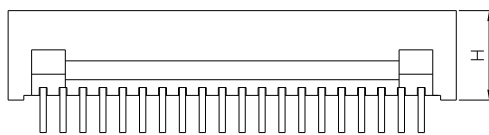
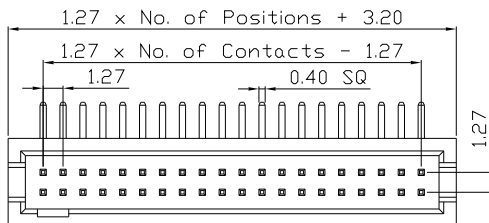
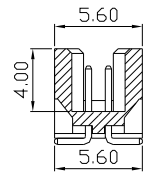
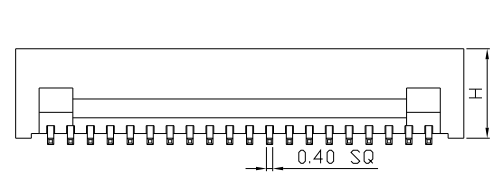
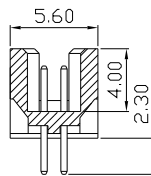
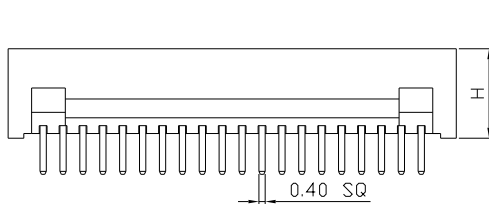
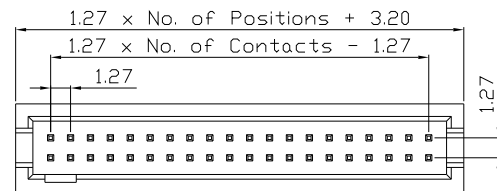
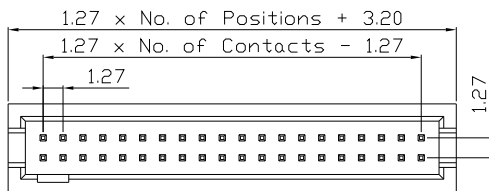

Ordering Code

①②③④⑤⑥⑦⑧⑨
30 3 X XX X X X X 0

① Series No.:
30 = Box Header

② Pitch:
3 = 1.27 x 1.27mm

③ Insulator Height:
4 = 5.4mm
7 = 5.7mm

④ Number of Contacts:
06 Pin - 98 Pin
X1 = 100 Pin

⑤ Tail & Mounting Style:
S = Straight Dip Type
R = Right Angle Dip Type
M = S.M.T Type

⑥ Contact Plated
0 = Tin
1 = Gold Flash
2 = Gold 3u"
3 = Gold 5u"
4 = Gold 10u"
5 = Gold 15u"
6 = Gold 30u"

⑦ Material Type
0 = PPS
1 = PBT
2 = LCP
3 = Nylon-66
4 = Nylon-6T
5 = PA46

⑧ Color:
B = Black
U = Blue
R = Red
W = White
Y = Yellow
G = Grey

⑨ Customer Request

Due to technical progress, all the information provided is subject to change without prior notice.